

Optical Connectors

Patch Cord	Single-fiber Optical Connector
	Simplex Patch Cord
	Duplex Patch Cord
MPO Cabling System	MPO Cabling System
	Optical Patch Panel and Connector Module
	MPO Connector
	Trunk Cable
	Patch Cord with Fiber-optic Connector for MPO Cabling System
Field Installable Connector	FAST™ Connector Series
	FAST™ Plus Connector
	FuseConnect™ Series
	FuseConnect™ for MPO
Mechanical Splices	Mechanical Splice Element
Cleaners	Push-Type Cleaners
	One-Click™ Cleaner PRO
	One-Click™ Cleaner MPO ESD



Single-fiber Optical Connector

Fujikura Simplex/Duplex Patch Cords support following optical connectors.

SC Connector



SC Connector

SC2 Connector (Note)
(Note) Special tools are required for attaching and detaching.

LC Connector

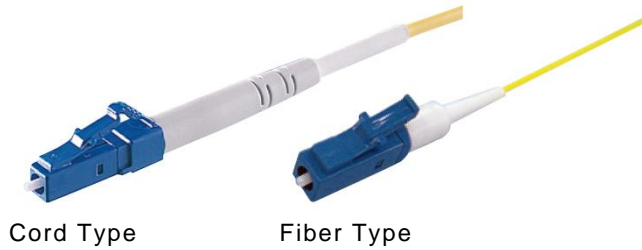

Cord Type

Fiber Type

MU Connector



MU Connector

MUJ Connector (Note)
(Note) Special tools are required for attaching and detaching.

FC Connector



Cord Type

Fiber Type

Duplex Type Connector



SCF Connector (SCF)

LC Connector (DXLC)

MU Connector (DXMU)



Contact us

Single-fiber Optical Connector Lineup for Simplex/Duplex Patch Cords

Optical Connector Type		Single Mode Fiber (SMF) / Multimode Fiber (MMF)							
		Polishing Method (MMF can only be PC polished.)				Cord Size [mm]			
		PC	SPC	UPC	APC	Fiber	Simplex Cord		Zipcord
						Ø 0.9	Ø 2	Ø 2.8	Ø 2 x 2
SC	SC	✓	✓	✓	✓	✓	✓	✓	✓
	SC2	✓	✓	✓		✓	✓	✓	✓
	SCF	✓	✓	✓		✓	✓	✓	✓
LC	LC	✓	✓	✓		✓	✓		✓
	DXLC	✓	✓	✓		✓	✓		✓
MU	MU	✓	✓	✓		✓	✓		✓
	MUJ	✓	✓	✓		✓	✓		✓
	DXMU	✓	✓	✓		✓	✓		✓
FC	FC	✓	✓	✓	✓	✓	✓	✓	✓

Optical Specifications of Single-fiber Optical Connector

Item		Single Mode	Multimode
Fiber Type		SM10/125 (R15, R30)	GI50/125 GI62.5/125
Applicable Optical Connectors		SC, LC, MU, FC	
Insertion Loss (against Master)	PC Polishing	0.5 dB or less	0.3 dB or less
	SPC Polishing		Not Supported
	UPC Polishing		
	APC Polishing (*1)		
Return Loss	PC Polishing	- (*2)	- (*2)
	SPC Polishing	40 dB or more	Not Supported
	UPC Polishing	50 dB or more	
	APC Polishing (*1)	60 dB or more	

(*1): SC2, LC and MU connectors do not support APC polishing.

(*2): If specification of the return loss is required, please contact Fujikura Sales.



Contact us

Simplex Patch Cord

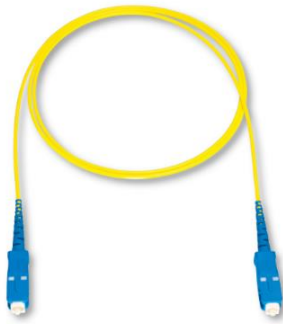

Simplex Patch Cord

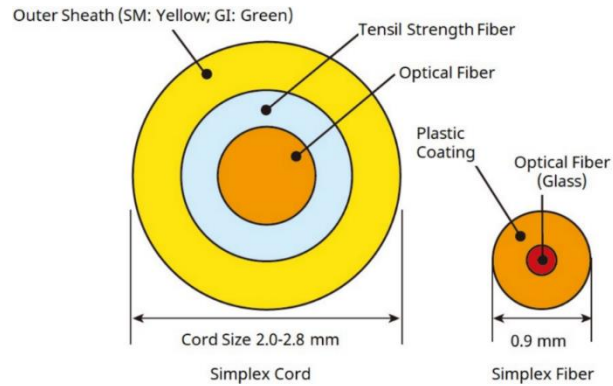

Both End with Connectors

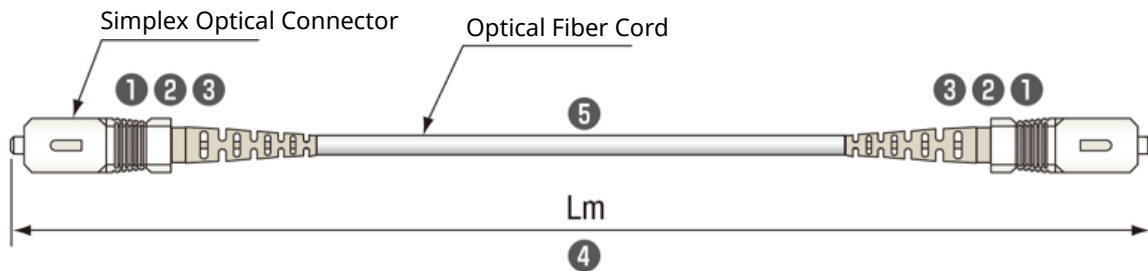

Model Number: **FSC-2PS-SPC-3M-SMC10/125-S**

① ② ③ ④ ⑤

①	②	③	④	⑤	
Connector Type (*1)	Connector at Fiber End	Polishing Type (*2)	Product Length (*3)	Fiber Type (*4)	
FSC: SC FSC2: SC2 FLC: LC FMU: MU FMUJ: MUJ FFC: FC	Single Mode Fiber 1PS: One End Only 2PS: Both Ends Multimode Fiber 1P: One End Only 2P: Both Ends	PC: PC Polishing SPC: SPC Polishing UPC: UPC Polishing APC: APC Polishing (SC, FC only)	Number in Metric (0.3 m or more)	Simplex Cord GC50/125-S: MM50 (Green), OM2 GC62.5/125-S: MM62.5 (Green), OM1 SMC10/125-S: SM (Yellow), R30 SR15E-SMC10/125-S: SM (Yellow), R15 GC50/125-S(10G): MM10G (Green), OM3	Simplex Fiber G50/125: MM50 (White), OM2 SM10/125: SM (White), R30 SR15E-SM10/125: SM (White), R15

(*1): When different connectors are attached at both ends, indicate FFC/FSC.

(*2): When polishing at both ends is different, indicate PC/SPC. Multimode fiber is PC polishing only.

(*3): Product length tolerances are shown below:

Product Length	Tolerance
$L \leq 1 \text{ m}$	+10 cm, -0
$1 \text{ m} < L \leq 10 \text{ m}$	+10%, -0
$10 \text{ m} < L \leq 50 \text{ m}$	+1 m, -0
$50 \text{ m} < L$	+2%, -0

(*4): For $\varnothing 0.9 \text{ mm}$ fiber and $\varnothing 2 \text{ mm}$ cord, color in () indicates coating color.



Contact us

Item	Model Number Example *	Connector 1	Connector 2	Fiber	Cord/ Fiber Color	Cord/ Fiber Diameter	Standard Product Length (m)	Overview
1	FSC-2PS-SPC-LM-SMC10/125-S	SC/SPC	SC/SPC	SM (R30)	Yellow	Ø 2 mm	L = 1, 2, 3, 5	SM (R30) Simplex Cord with SC Connectors at Both Ends
2	FSC-2PS-SPC-LM-SR15E-SMC10/125-S	SC/SPC	SC/SPC	SM (R15)	Yellow	Ø 2 mm	L = 1, 2, 3, 5	SM (R15) Simplex Cord with SC connectors at Both Ends
3	FLC-2PS-SPC-LM-SR15E-SMC10/125-S	LC/SPC	LC/SPC	SM (R15)	Yellow	Ø 2 mm	L = 1, 2, 3, 5	SM (R15) Simplex Cord with LC connectors at Both Ends
4	FSC-2P-PC-LM-GC50/125-S	SC/PC	SC/PC	MM50	Green	Ø 2 mm	L = 1, 2, 3, 5	GI 50/125 Simplex Cord with SC connectors at Both Ends
5	FSC-2P-PC-LM-GC62.5/125-S	SC/PC	SC/PC	MM62.5	Green	Ø 2 mm	-	GI 62.5/125 Simplex Cord with SC connectors at Both Ends
6	FSC/FLC-2P-PC-LM-GC50/125-S	SC/PC	LC/PC	MM50	Green	Ø 2 mm	-	GI 50/125 Simplex Cord with LC Connector at One End and SC Connector at Other End
7	FSC-1PS-SPC-LM-SR15E-SMC10/125-S	SC/SPC	LC/PC	SM (R15)	Yellow	Ø 2 mm	L = 1, 2, 3, 5	SM (R15) Simplex Cord with SC Connector at One End Only
8	FSC-2PS-SPC-LM-SM10/125	SC/SPC	SC/SPC	SM (R30)	White	Ø 0.9 mm	-	SM Simplex Fiber with SC Connectors at Both Ends
9	FSC-2P-PC-LM-G50/125	SC/PC	SC/PC	MM50	White	Ø 0.9 mm	-	GI 50/125 Simplex Fiber with SC Connectors at Both Ends

* Specify the total length (m) for L



Contact us

Duplex Patch Cord

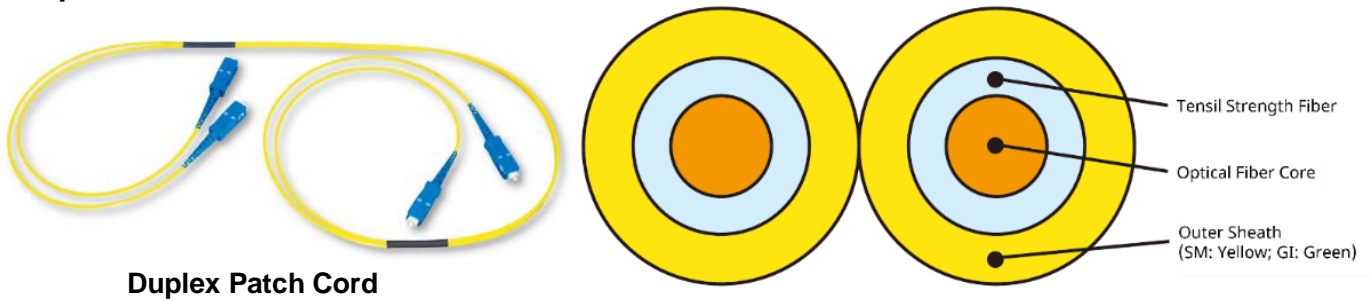

Both End with Connectors

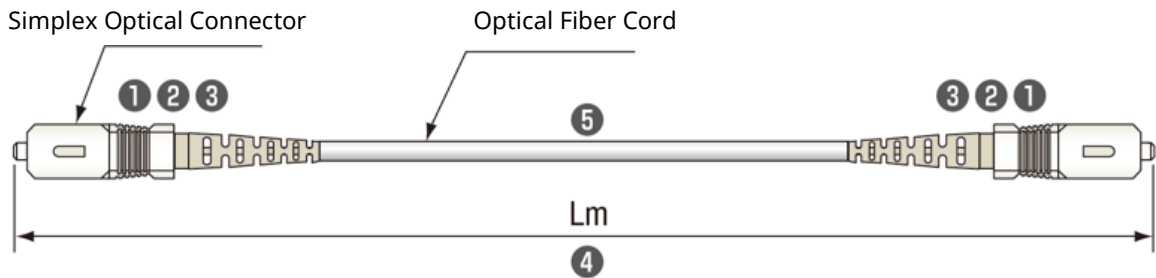

Model Number: **FSC-2PS-SPC-3M-SMC10/125-S**

① ② ③ ④ ⑤

①		②	③	④	⑤
Connector Type (*1)		Connector at Fiber End	Polishing Type (*2)	Product Length (*3)	Fiber Type (*4)
Simplex Connector FSC: SC FSC2: SC2 FMU: MU FMUJ: MUJ FLC: LC FFC: FC	Duplex Connector FSCF: SCF DXMU: DXMU DXLC: DXLC	Single Mode Fiber 1PS: One End Only 2PS: Both Ends Multimode Fiber 1P: One End Only 2P: Both Ends	PC: PC Polishing SPC: SPC Polishing UPC: UPC Polishing APC: APC Polishing (SC, FC only)	Number in Metric (1.0 m or more)	Simplex Cord GC50/125-2SR: MM50 (Green), OM2 GC62.5/125-2SR: MM62.5 (Green), OM1 SMC10/125-2SR: SM (Yellow), R30 SR15E-SMC10/125-2SR: SM (Yellow), R15 GC50/125-2SR (10G): MM10G (Green), OM3

(*1): When different connectors are attached to both ends, use FFC/FSC notation.

(*2): When polishing with different ends, indicate PC/SPC notation. Multimode fiber is PC polishing only.

(*3): Product length tolerances are shown below:

Product Length	Tolerance
1 m < L ≤ 10 m	+10%, -0
10 m < L ≤ 50 m	+1 m, -0
50 m < L	+2%, -0

(*4): Color in () indicates coating color.

(*5): When duplex connectors (SCF, DXLC, DXMU) are installed on both ends, polarity specification (1X, -ST) is required. Standard Branch Length is 0.5 m. (Please contact us for short items.)



Contact us

Item	Model Number Examples	Connector 1	Connector 2	Fiber	Cord Color	Cord Diameter	Standard Total Length (m)	Overview
1	FSC-2PS-SPC-LM-SMC10/125-2SR	SC/SPC	SC/SPC	SM (R30)	Yellow	∅ 2 mm x 2	L = 1, 2	SM (R30) Zipcord with SC Connectors at Both Ends
2	FLC-2PS-SPC-LM-SMC10/125-2SR	LC/SPC	LC/SPC	SM (R30)	Yellow	∅ 2 mm x 2	L = 2, 3, 5	SM (R30) Zipcord with LC Connectors at Both Ends
3	FSC/FLC-2PS-SPC-LM-SMC10/125-2SR	SC/SPC	LC/SPC	SM (R30)	Yellow	∅ 2 mm x 2	L = 2, 3, 5	SM (R30) Zipcord with SC Connector at One End and LC Connector at Other End
4	FSC-2PS-SPC-LM-SR15E-SMC10/125-2SR	SC/SPC	SC/SPC	SM (R15)	Yellow	∅ 2 mm x 2	L = 1, 2, 3, 5	SM (R15) Zipcord with SC Connectors at Both Ends
5	FLC-2PS-SPC-LM-SR15E-SMC10/125-2SR	LC/SPC	LC/SPC	SM (R15)	Yellow	∅ 2 mm x 2	L = 1, 2, 3, 5	SM (R15) Zipcord with LC Connectors at Both Ends
6	FSC/FLC-2PS-SPC-LM-SR15E-SMC10/125-2SR	SC/SPC	LC/SPC	SM (R15)	Yellow	∅ 2 mm x 2	L = 1, 2, 3, 5	SM (R15) Zipcord with SC Connector at One End and LC Connector at Other End
7	FSC-2P-PC-LM-GC50/125-2SR	SC/PC	SC/PC	MM50	Green	∅ 2 mm x 2	L = 1, 2, 3, 5	GI 50/125 Zipcord with SC Connectors at Both Ends
8	FLC-2P-PC-LM-GC50/125-2SR	LC/PC	LC/PC	MM50	Green	∅ 2 mm x 2	L = 1, 2, 3, 5	GI 50/125 Zipcord with LC Connectors at Both Ends
9	FSC/FLC-2P-PC-LM-GC50/125-2SR	SC/PC	LC/PC	MM50	Green	∅ 2 mm x 2	L = 1, 2, 3, 5	GI 50/125 Zipcord with SC Connector at One End and LC Connector at Other End
10	FSCF/DXLC-2PS-SPC-LM-SMC10/125-2SR-X	SCF/SPC	DXLC/SPC	SM (R30)	Yellow	∅ 2 mm x 2	—	SM (R30) Zipcord with Duplex SC Connector at One End and Duplex LC Connector at Other End (Cross)
11	FSCF-2PS-PC-LM-GC50/125-2SR-ST	SCF/PC	SCF/PC	MM50	Green	∅ 2 mm x 2	—	GI 50/125 Zipcord with Duplex SC Connectors at Both Ends (Straight)



Contact us

Fiber-optic Cabling System Using 12-Fiber MPO (12MPO) Connectors for Data Centers

Features

- High-Speed, High-Capacity Transmission**
 Our high-performance optical fiber supports current 10GbE networks and is ready for future upgrades to 40GbE and 100GbE, ensuring long-term scalability and superior data transmission capabilities.
- Rapid Installation**
 The Fujikura fiber-optic cabling system is designed for efficiency, featuring pre-terminated fiber-optic connectors that facilitate a plug-and-play setup. This design dramatically reduces installation time, making it ideal for data centers needing swift deployment.
- Unmatched Reliability**
 Every Fujikura product is processed and assembled in a meticulously controlled factory environment. This ensures that our fiber-optic cabling systems offer exceptional reliability, eliminating the need for direct handling of optical fibers within your data center.
- Superior Performance**
 Utilizing wideband multimode optical fiber, our system extends transmission distances significantly. For example, 10GBASE-SR transmissions can reach up to 300 meters with OM3 and 400 meters with OM4, providing flexibility and enhanced performance for various applications.
- High-Density Solutions**
 Our trunk cables with 12MPO connectors minimize cabling volume, while our modular patch panels support high-density mounting. This design optimizes space and enhances the efficiency of your data center infrastructure.
- Quick Recovery**
 In the event of cable damage, the FuseConnect™ splice-on connector enables swift and effective recovery. This feature ensures minimal downtime and maintains the operational integrity of your fiber-optic cabling system.

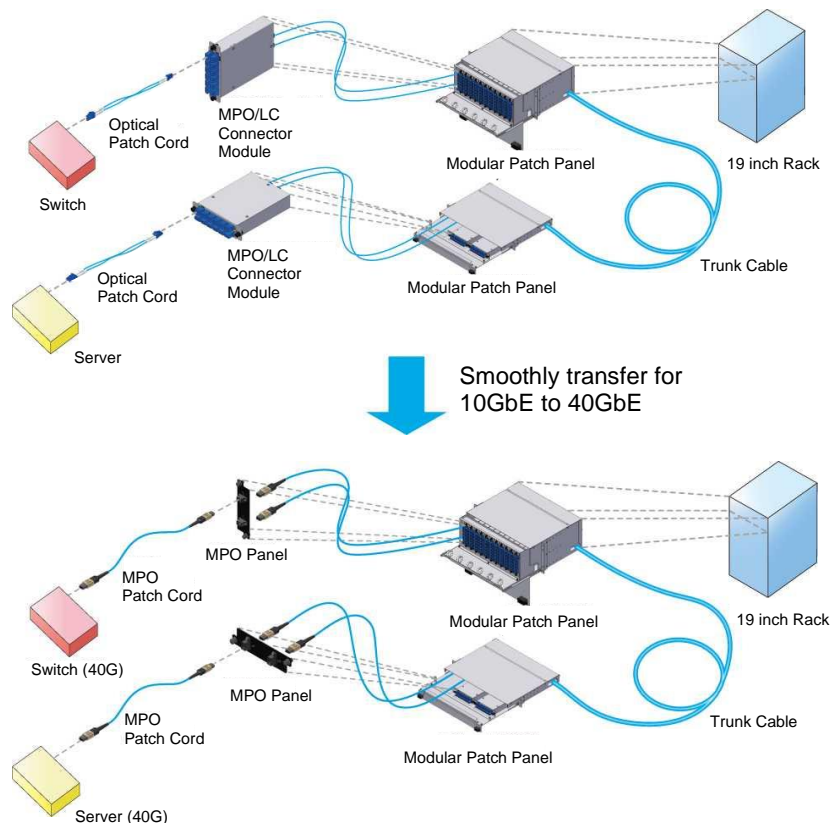

Contact us

Optical Patch Panel and Connector Module

Versatile Deployment and Easy Integration

- Comprehensive Module Deployment: Suitable for various areas, including main distribution for networking.
- Diverse Range of Options: Choose from modular types to adapter panel types for optimal customization.
- Efficient and Reliable Systems: Plug-and-play connections ensure quick, easy installation and reliable performance.
- Seamless Integration: Compatible with various trunk cables and patch cords for flexible and scalable network solutions. Feel free to combine them with various trunk cables and patch cords.

Patch Panel Chassis & Modules



FBC514P-1U



FBC514M-24LC-SM



FBC514MA-2MPO

Features

Versatile and High-Density Fiber Optic Solutions

- High-Density Mounting: Our modules are designed for high-density mounting in the chassis, ensuring efficient use of space and easy insertion and removal of connectors.
- Flexible Connectivity: The trunk cable features a multi-fiber MPO connector, with options to choose LC or SC connectors on the patch cord side for versatile connectivity.
- Dual Cabling Support: Each module supports both type A and type B cabling, providing flexibility and compatibility with various cabling standards.

Patch Panel Chassis

FBC514P-[]	1U	2U	4U
Installation Type	19 inch Rack (EIA Standard)		
Configuration	Connector + (Module) + Connector		
Cable Entry	Rear Side (Right and Left)		
Number of Cables	Max. 6	Max. 6	Max. 12
Number of Modules	Max. 3	Max. 6	Max. 12
Color	Black		
Dimensions (mm)	W 482.6 x H 43.7 x D 360	W 482.6 x H 88.1 x D 360	W 482.6 x H 177 x D 400



Contact us

Module

FBC514M-[]	24LC-SM	24LC-MM	24LC-LM
Connector Type	LC Duplex: 12 pcs, MPO (Male): 2 pcs		
Insertion Loss (dB)	Max. 1.3	Max. 0.9	Max. 0.5

FBC514M-[]	12SC-SM	12SC-MM	12SC-LM
Connector Type	SC Duplex: 6 pcs, MPO (Male): 1 pc		
Insertion Loss (dB)	Max. 1.3	Max. 0.9	Max. 0.5

FBC514M-[]	2MPO
Connector Type	MPO: 2 pcs

Adapter Panel & Cord Storage Tray

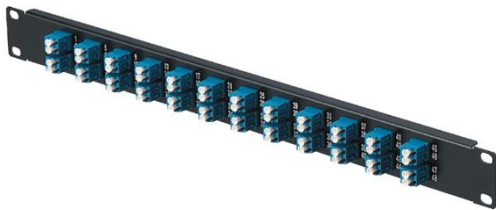

FBC514A-48LC-BL



FBC514T-02

Features

- Utilizes a combination of adapter panel and cord storage tray.
- Supports LC, SC, and MPO connectors.

Adapter Panel

FBC514M-[]	48LC-aa	24SC-aa	12MPO
Connector Type	19 inch Rack (EIA Standard)		
Insertion Loss (dB)	LC Duplex: 24 pcs	SC Duplex: 12 pcs	MPO: 12 pcs
Color	Black		
Dimensions (mm)	W 482.6 x H 43.7 x D 10 (not including adapter)		

Cord Storage Tray

FBC514T-[]	02
Installation Type	19 inch Rack (EIA Standard)
Cable Entry	Front, Rear, Right and Left: 2 each (8 in total)
Color	Black
Dimensions (mm)	W 482.6 x H 43.7 x D 360



Contact us

MPO Connector



MPO Connector



24-Fiber MPO Connector

Features

- Advanced multi-fiber connector solutions
- MT ferrule multi-fiber connector: Utilizes an MT ferrule, with a 24-fiber type available in our lineup.
- Low-loss performance: Designed to deliver low loss even as a multi-fiber connector, ensuring reliable and efficient data transmission.

12-Fiber MPO (12MPO) Connector

		Single Mode Fiber (OS2)	Multimode Fiber (OM3, OM4)
Fiber Count		12	12
Insertion Loss (against Master)	Standard Grade	≤ 1.0 dB	≤ 0.6 dB
	Low-Loss Grade	≤ 0.35 dB	≤ 0.2 dB
Return Loss		≥ 55 dB	-
Polishing Type		APC	PC
Conforming Standard		JIS C5982 (F13) IEC-61754-7	

24-Fiber MPO (24MPO) Connector

		Single Mode Fiber (OS2)	Multimode Fiber (OM3, OM4)
Fiber Count		24	24
Insertion Loss (against Master)	Standard Grade	≤ 1.0 dB	≤ 0.75 dB
	Low-Loss Grade	≤ 0.35 dB	≤ 0.35 dB
Return Loss		≥ 55 dB	-
Polishing Type		APC	PC



Contact us

Trunk Cable



Features

- Efficient trunk cable solutions
- Data center connectivity: Trunk cables are ideal for connecting racks and rooms within data centers.
- Pre-installed connectors: Delivered with MPO and simplex connectors installed for ready-to-use convenience.
- Flexible packaging options: Available with tow-ends and reel packaging to suit various installation environments.

MPO – MPO

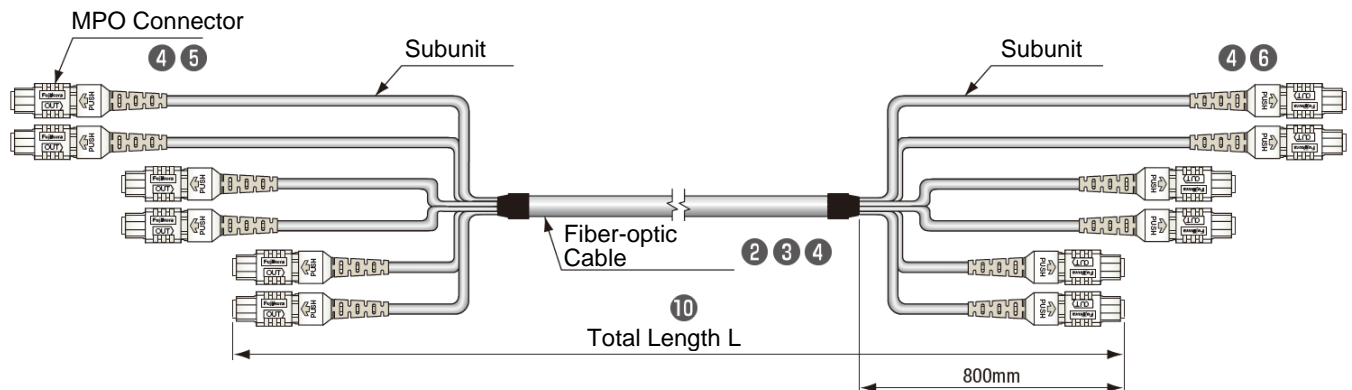

MPO – Single-fiber Connector (Fan-out)

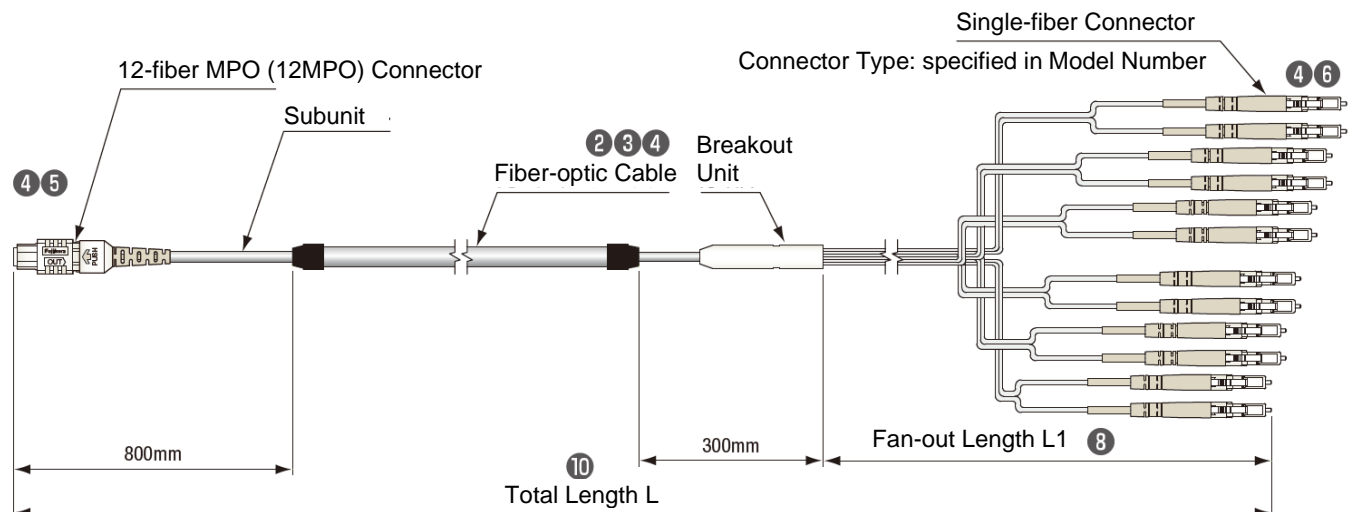

Contact us

Single-fiber Connector (Fan-out) – Single-fiber Connector (Fan-out)

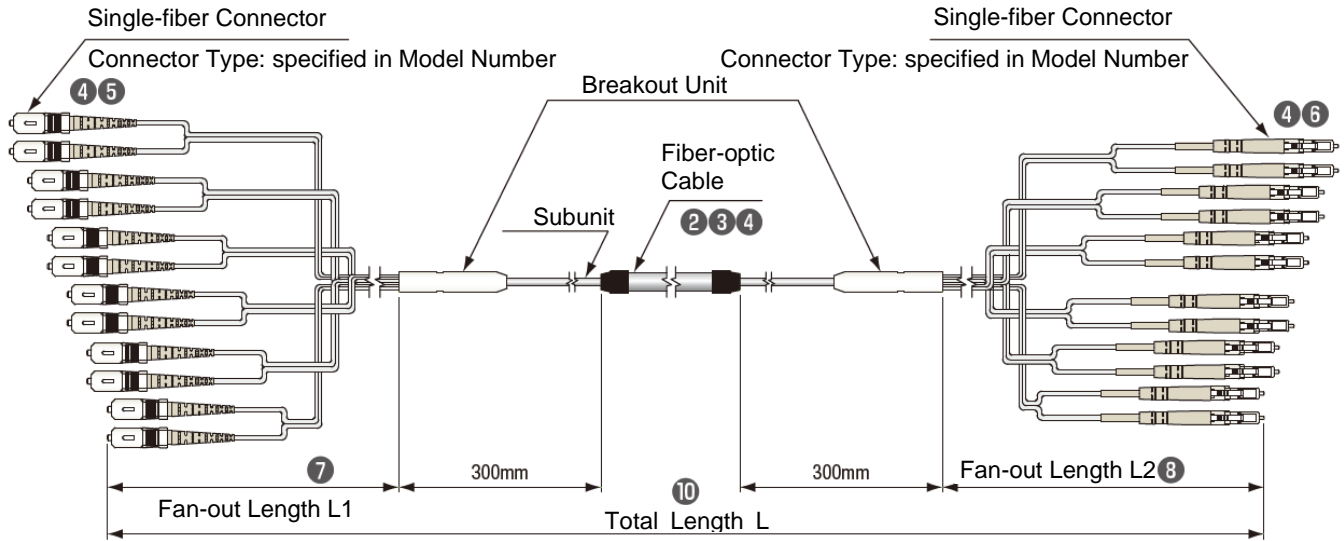

Model Number : FJ-■-■■■ ■■■■-■■■ M ■■■■

1
2
3
4
5
6
7
8
9
10
11

1	2	3	4
Polarity (TIA-568-C.3)	Cable Type	Fiber Type & Jacket Color	Fiber Count
A: Type A	K: Trunk Cable • Flame-retardant Rating: Plenum	SY: SM, OS2, Yellow LA: MM 50 um, OM3-BIF, Aqua CA: MM 50 um, OM4-BIF, Aqua • BIF: Bend-insensitive Fiber	2: 2 fibers 4: 4 fibers 6: 6 fibers 8: 8 fibers C: 12 fibers D: 24 fibers E: 36 fibers F: 48 fibers • Indicates number of fibers for connector termination



Contact us

56	78	9
Connector Type	Fan-out Length L1, L2	Pulling Eye
<p>MPF: 12MPO (Female) MPM: 12MPO (Male) LPF: Low-loss 12MPO (Female) LPM: Low-loss 12MPO (Male) SSC: Simplex SC (PC) SSA: Simplex SC (APC) SLC: Simplex LC (PC) UCO: No Connector</p> <ul style="list-style-type: none"> • PC: UPC for SM • Please contact us for further assistance to ensure support for the duplex connector. It is essential to verify the wiring configuration. 	<p>A: Fixed Length for MPO B: 500 mm C: 1000 mm D: 1500 mm E: 2000 mm</p>	<p>A: No Pulling Eye B: Pulling Eye on Side B (end) (*1) C: Pulling Eyes on Both Ends</p> <p>(*1) Assembly Priority in case of B 1st Priority: No Connector Side 2nd Priority: MPO Side 3rd Priority: Single-fiber Connector Side (*2)</p> <p>(*2) Maximum Fiber Count for Single-fiber Connectors: LC: 48 fibers or less SC: 24 fibers or less</p>

10	11
Total Length L (3 digits)	Packaging Type (Bundled/Reeled)
<p>001: 1 m 010: 10 m 100: 100 m</p> <ul style="list-style-type: none"> • Tolerance L ≤ 10 m : +10%, -0 10 m < L ≤ 50 m: +1 m, -0 50 m < L: +2%, -0 • Minimum Length MPO – MPO: 3 m or more MPO – Single-fiber Connector: 7 m or more Single-fiber Connector – Single-fiber connector: 10 m or more 	<p>C: Bundled R: Reeled</p>



Contact us

Structure of Trunk Cable

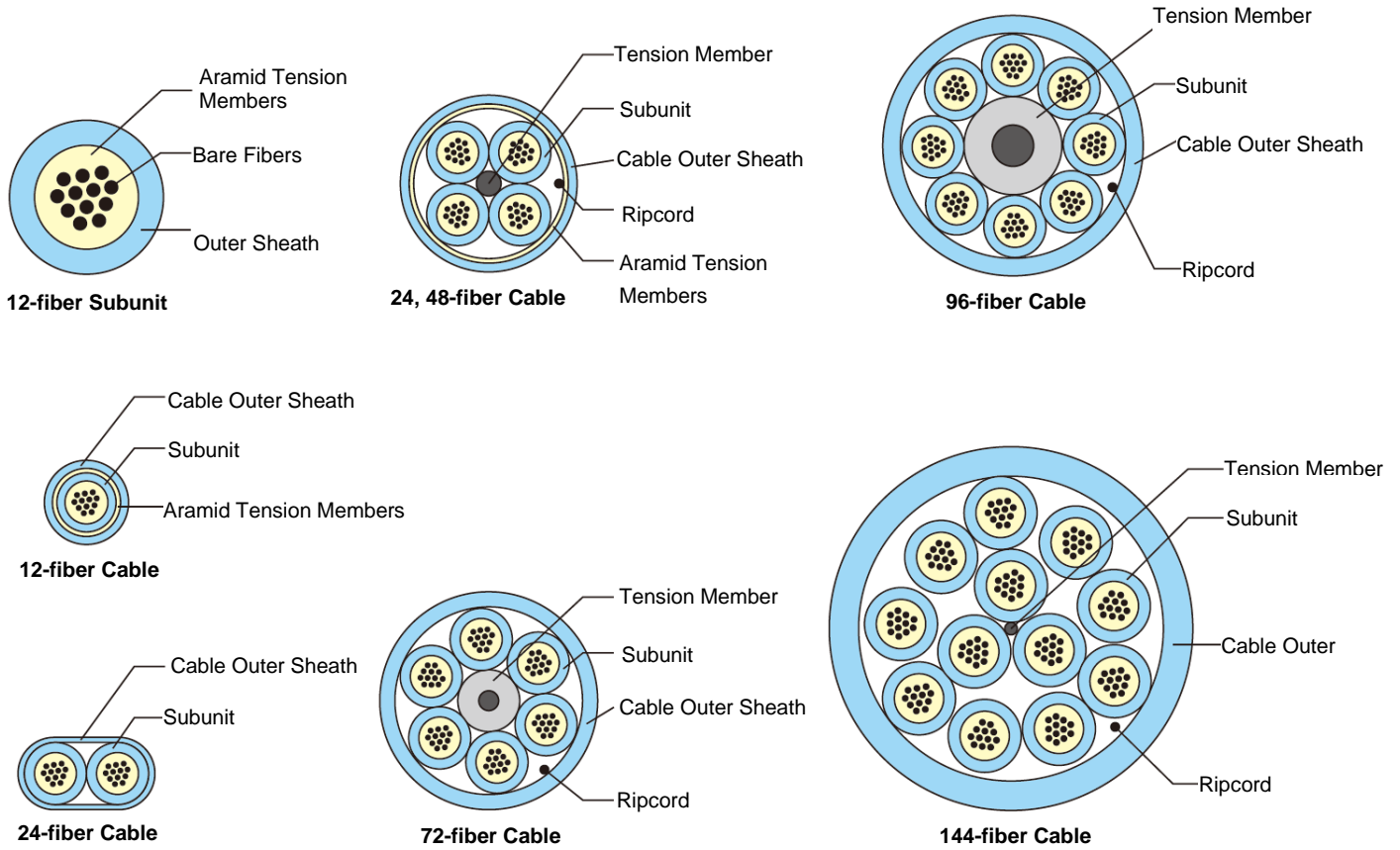

Type	Trunk Cable						
Fiber Count	12	24	24	48	72	96	144
Outer Diameter (mm)	4.5	4.5 x 7.4	9.7		11.1	13.3	14.9
Weight (kg/km)	22	33	80		125	175	194
Sheath Color	OS2: Yellow OM3/OM4: Aqua						
Flame-retardant Rating	Plenum (OFNP UL910)						



Contact us

Reel

Compact and Eco-Friendly Reel Packaging

Durable Construction: The reel features a wooden board and paper tube body, assembled with bolts and nuts for easy disassembly and disposal on-site.

Compact Design: Available in flange diameters of 44 cm and 60 cm, making it easy to transport into server rooms.

Eco-Friendly Materials: The materials are resistant to wood waste, ensuring suitability for use within the server room environment.



Pulling Eye

Adaptable Pulling Eye Design

Variable Outer Diameter: The outer diameter of the pulling eye ranges from 30 to 50 mm, tailored to the fiber count and the number of connectors.

Customizable Length: The length of the pulling eye is adjustable based on the fan-out length and the quantity of connectors, ensuring a precise fit for your specific installation needs.



Contact us

Patch Cord with Fiber-optic Connector for MPO Cabling System

Features

- Optimized patch cord solutions
- Ideal for short-distance connections: Specifically designed for short-distance connections or intra-rack use within data centers.
- Pre-terminated connectors: Supplied with MPO and single-fiber connectors, enabling quick and efficient installations.

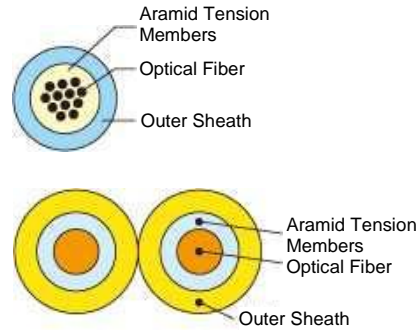

Simplex Connector

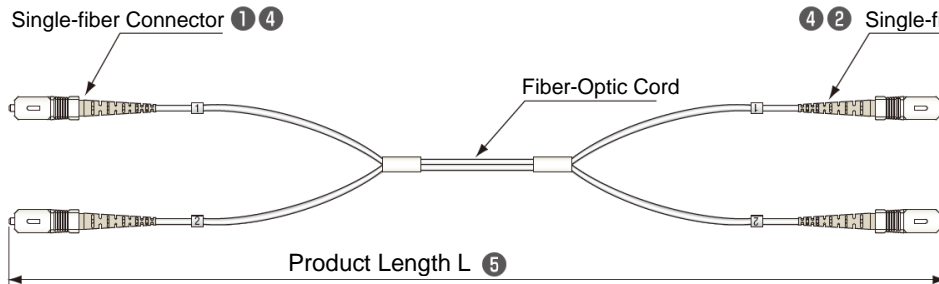

Duplex Connector

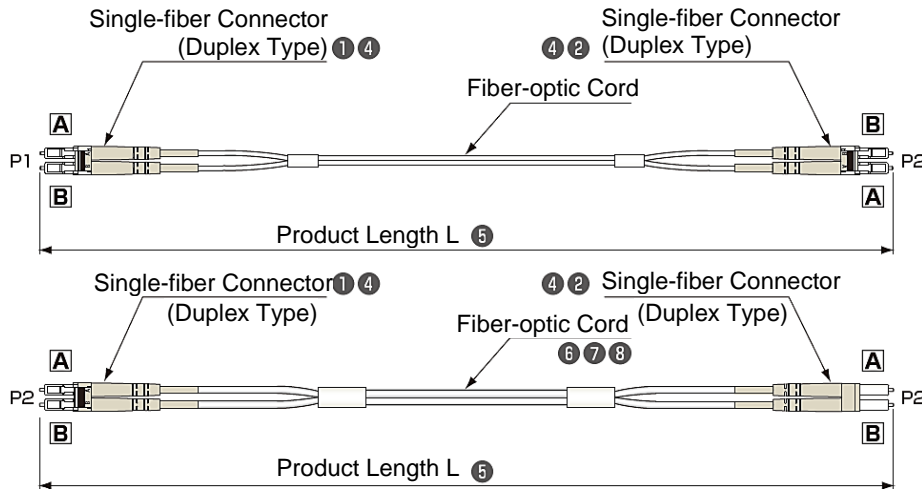

Polarity of Duplex Connectors

Duplex connectors on both ends exhibit polarity. Please specify one of the following two polarities (X: Cross Connection, ST: Straight Connection) and include it in the model number when placing an order.

Symbol	Polarity	
	From: P1	To: P2
X	A → B	B → A
	B → A	A → B
ST	A → A	B → B
	B → B	A → A

MPO Connector

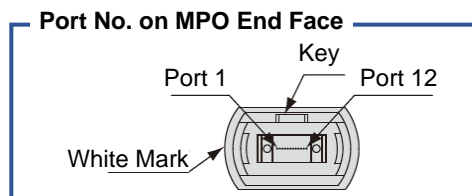
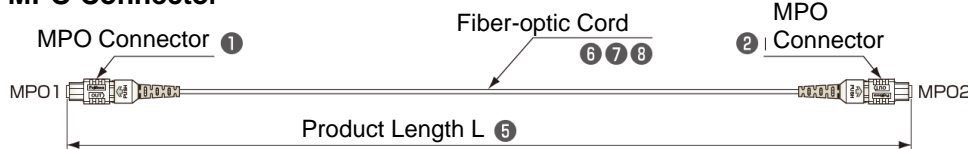

Polarity of MPO Connectors

MPO connectors on both ends exhibit polarity. Please specify one of the following two polarities (X: Cross Connection, ST: Straight Connection) and include it in the model number when placing an order.

ST: Straight Connection		X: Cross Connection	
MPO1 Port No.	MPO2 Port No.	MPO1 Port No.	MPO2 Port No.
1	1	1	12
2	2	2	11
3	3	3	10
4	4	4	9
5	5	5	8
6	6	6	7
7	7	7	6
8	8	8	5
9	9	9	4
10	10	10	3
11	11	11	2
12	12	12	1



Contact us

Model Number : **■ / ■ - 2P ■ - ■ - ■ M - (■ -) ■ - ■**
① ② ③ ④ ⑤ ⑥ ⑦ ⑧

①②	③	④
Connector Type	Fiber Type	Polishing Type
FSC: Simplex SC FLC: Simplex LC DXSC: Duplex SC DXLC: Duplex LC 12MPOF: 12MPO (Female) 12MPOM: 12MPO (Male) P12MPOF: Low-loss 12MPO (Female) P12MPOM: Low-loss 12MPO (Male) <ul style="list-style-type: none"> • 12MPO: 12-fiber MPO • ② could be omitted when both ends are the same connector. 	No entry: MM S: SM	PC SPC UPC APC (SC only) <ul style="list-style-type: none"> • Specify polishing such as PC/SPC for different polished ends. Omit for MPO. • SM is APC polishing and MM is PC polishing.

⑤	⑥
Product Length L	Flame-retardant Option (Optional)
Metric (1.5 m or greater) <ul style="list-style-type: none"> • Tolerance L ≤ 10 m: +10%, -0 10 m < L ≤ 50 m: +1 m, -0 50 m < L: +2%, -0 	No Symbol: PVC, flame-retardant not specified RS: Riser Grade PL: Plenum Grade <ul style="list-style-type: none"> • 3 mm dia. 12-fiber round cord is Plenum grade.

⑦	⑧
Fiber Type & Cord Shape	Polarity
SMC-S: Single-fiber Cord, SM, 2 mm SR15EC-S: Single-fiber Cord, SM SR15E, 2 mm SMC-2 SR: Zipcord, SM, 2 mm SR15EC-2SR: Zipcord, SM SR15E, 2 mm OM3C-2SR: Zipcord, MM 50 um, OM3, 2 mm OM4C-2SR: Zipcord, MM 50 um, OM4, 2 mm SMCx12C: 12-fiber Round Cord, SM, 3 mm OM3Cx12C: 12-fiber Round Cord, MM 50 um, OM3, 3 mm OM4Cx12C: 12-fiber Round Cord, MM 50 um, OM4, 3 mm	X: Cross Connection ST: Straight Connection <ul style="list-style-type: none"> • Specify only for duplex and MPO connectors at both ends.

Ordering Model Number Example

DXLC-2P-PC-3M-RS-OM3C-2SR-X
 OM3 Duplex LC Connector on Both Ends, Zipcord, Riser Grade, Aqua, DXLC-DXLC, 3m, Cross Connection

12MPOF-2PS-SM-PL-SMCx12C-ST
 SM MPO Connector at both ends, 12-fiber Cord, Plenum Grade, Yellow, MPO (Female) -MPO (Female), 2 m, Straight Connection



Contact us

FAST™ Connector Series

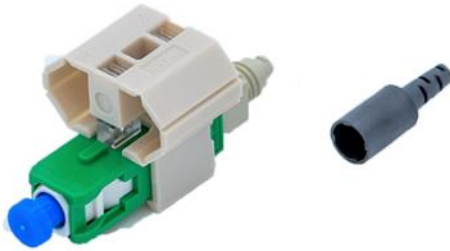

FAST connectors are factory pre-polished, field-installable connectors that eliminate the need for hand polishing in the field. Proven mechanical splice technology ensures precise fiber alignment, a factory pre-cleaved fiber stub, and a proprietary index-matching gel, all combined to offer an immediate low-loss termination for either single-mode or multimode optical fibers.

Features

- Easy field installation through a simplified process, without the need for electrical power, epoxy, or field polishing.
- FAST connectors are designed to accommodate 0.25 mm / 0.9 mm coated fiber, 2 mm / 3 mm cords, and rectangular-shaped outdoor/indoor cables.
- FAST connectors demonstrate high performance when combining SC/LC/ST connectors and mechanical splices.

Structure of Mechanical Splice

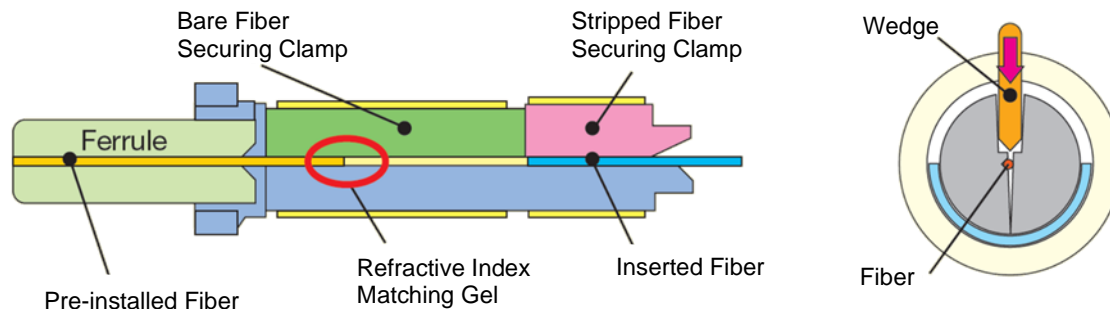

Polished optical fiber is pre-affixed at the tip of the connector and stripped fiber is cleaved, aligned and meets the pre-installed fiber, where connection is done via mechanical splice method.



Contact us

Assembly Flow of FAST Connector (0.25 / 0.9 mm Fiber Type)

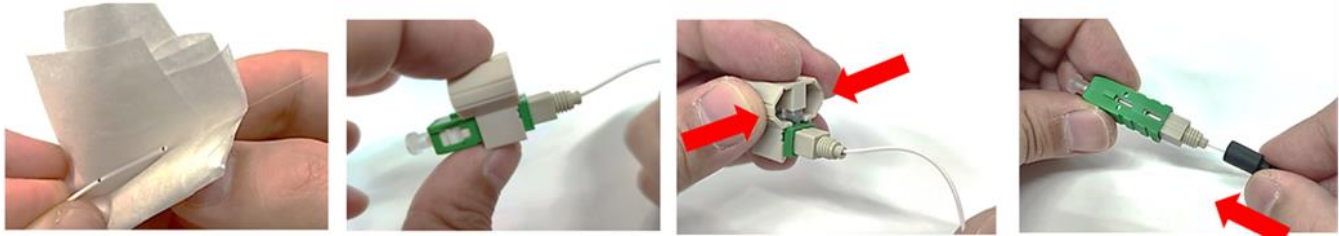

1. Fiber preparation

2. Insert the cleaved fiber into the connector

3. Create a slight bend to maintain contact. Release the wedge clip by squeezing both sides and remove the wedge clip.

4. Lastly, push the boot onto the connector's body

Specifications

1. 0.25 mm / 0.9 mm Fiber, 2 mm / 3 mm Cord

Applicable Fiber / Cord	0.25 mm fiber (240-265 μm), 0.9 mm fiber (850-950 μm), 2 mm cord (Ø 2, 0.9 mm fiber inside), 3 mm cord (Ø 3, 0.9 mm fiber inside)		
Connector	SC, LC, ST		
Fiber	SM		MM (OM1, OM2, OM3) (*1)
Polishing	SPC	APC	PC
Housing Color	Blue	Green	OM1: Beige, OM2: Black, OM3: Aqua
Insertion Loss (*2)	≤ 0.5 dB	≤ 0.6 dB	≤ 0.4 dB
Return Loss (*2)	≥ 40 dB	≥ 50 dB (*3)	-

2. Rectangular Shaped Cable (Outdoor / Indoor)

Applicable Fiber	Outdoor cable (3.1 x 2 mm), Indoor cable (2 x 1.6 mm) (*4)	
Connector	SC, LC (*5)	
Fiber	SM	
Polishing	SPC	APC
Housing Color	Blue	Green
Insertion Loss (*2)	≤ 0.5 dB	≤ 0.6 dB
Return Loss (*2)	≥ 40 dB	≥ 50 dB (*3)

*1. OM1: GI 62.5/125, IEC 60793-2-10 A1b, OM2: GI 50/125, IEC 60793-2-10 A1a.1, OM3: GI 50/125, IEC 60793-2-10 A1a.2

*2. with reference connector, SM @ 1310, 1550 nm, MM @ 850, 1310 nm

*3. Internal fiber is flat cleaved. Angle cleaved is available.

*4. For other cable types, please consult with us.

*5. Only indoor cable is available.



Contact us

Ordering Information

1. 0.25 mm / 0.9 mm Fiber, 2 mm / 3 mm cord:

Fiber	Polishing	SC	LC	ST
SM	SPC	FAST-SC-SM-ALL	FAST-LC-SM-ALL	FAST-ST-SM-ALL
	APC	FAST-SC-APC-SM-ALL	FAST-LC-APC-SM-ALL	-
MM (OM1)	PC	FAST-SC-GI6-ALL	FAST-LC-GI6-ALL	FAST-ST -GI6-ALL
MM (OM2)	PC	FAST-SC-GI5-ALL	FAST-LC-GI5-ALL	FAST-ST-GI5-ALL
MM (OM3)	PC	FAST-SC-10G-ALL	FAST-LC-10G-ALL	FAST-ST-10G-ALL

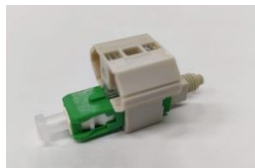

FAST-SC-APC-SM-ALL



0.9 mm Boot



0.9 mm Spacer Tube



2 mm Boot



3 mm Boot

2. Rectangular Shaped Cable (Outdoor / Indoor)

Fiber	Polishing	SC	LC (*6)	ST
SM	SPC	FAST(N)-SC-SM-UNI/GT (*E)	FAST-LC-SM-LF/GT	-
	APC	FAST(N)-SC-APC-SM-UNI/GT	FAST-LC-APC-SM-LF/GT	-

*6. Only indoor cable available

*E. FAST(N)-SC-SM-UNI/GT



Contact us

FAST™-Plus Connector

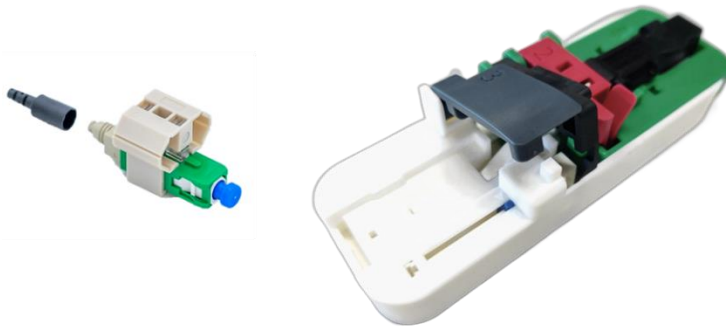

FAST™-Plus introduces a special cleave tool, maintenance free cleaver and a new type of index matching material, called ‘solid gum’ which is combined with the existing index matching gel.

Due to the blade design and operation, the maintenance free cleaver produces a highly repeatable and high-quality fiber cleave condition which enables an exceptional ‘first time pass’ connection; meaning an OPEX reduction in customer site revisits. Due to the fact Fujikura supply the maintenance free cleaver as a pre-packaged accessory with every box of FAST™-PLUS; the CAPEX normally associated with the use of a high precision cleave tool is therefore completely negated.

In conclusion, the FAST™ PLUS product range will benefit operators in their FTTH networks builds, especially in their access network where speed, accuracy and repeatable good results matter.

Hybrid Matching Material

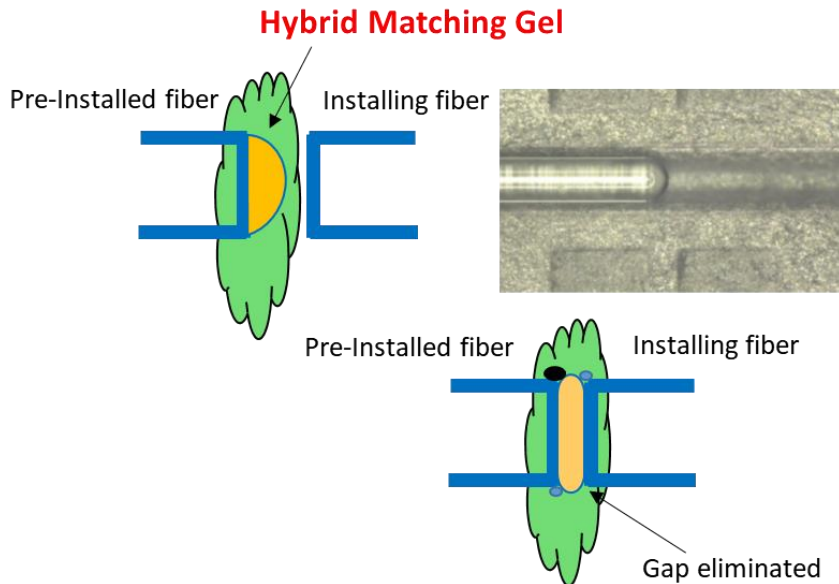

FAST™-Plus connector comes with a new type of index matching material, called ‘solid gum’ which is combined with the existing index matching gel. This technology fills tiny gaps between the pre-installed fiber and the installing fiber. On top of that, it prevents air bubbles and contaminations from moving.



Contact us

Maintenance-Free Cleaver

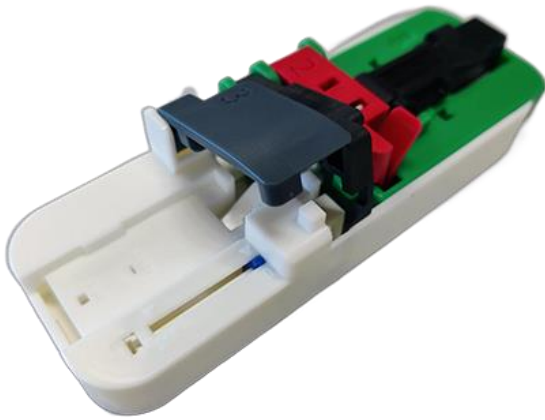

Features

- Complementary, comes with every 100 connectors
- No cleaver investment needed, CAPEX reduction
- Easy to operate
- Every cleave is a good cleave

Fiber End Face

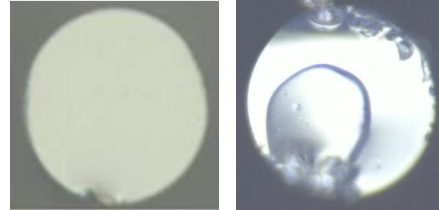

Good Cleave

Bad Cleave

Specifications

Applicable Fiber/code	0.25 mm Fiber (240–265 μm), 0.9 mm Fiber (850–950 μm), 2 mm Cord, 3 mm Cord				
Connector	SC, LC				
Fiber	SM (*1)		MM (OM1) (*2)	MM (OM2) (*3)	MM (OM3) (*4)
Polishing	UPC	APC	PC		
Housing Color	Blue	Green	Beige	Black	Aqua
Insertion Loss (*5)	≤ 0.5 dB	≤ 0.6 dB	≤ 0.4 dB		
Return Loss (*5)	≥ 45 dB (Typical 50 dB)	≥ 60 dB (Typical 65 dB)	-		

*1. SM ITU-T G. 625D, ITU-T G.657.A1 (ITU-T G.657.A2 type is also available, please contact us.)

*2. GI 62.5/125, IEC 60793-2-10 A1b

*3. GI 50/125, IEC 60793-2-10 A1a.1

*4. GI 50/125, IEC 60793-2-10 A1a.2

*5. with reference connector, SM @ 1310, 1550 nm, MM @ 850, 1310 nm

Ordering Information

Fiber	Polishing	SC	LC
SM	UPC	FAST-SC-PLUS-UPC-A1-ALL	FAST-LC-PLUS-UPC-A1-ALL
	APC	FAST-SC-PLUS-APC-A1-ALL	FAST-LC-PLUS-APC-A1-ALL
MM (OM1)	PC	FAST-SC-PLUS-GI6-ALL	FAST-LC-PLUS-GI6-ALL
MM (OM2)	PC	FAST-SC-PLUS-GI5-ALL	FAST-LC-PLUS-GI5-ALL
MM (OM3)	PC	FAST-SC-PLUS-10G-ALL	FAST-LC-PLUS-10G-ALL



Contact us

FuseConnect™ Series

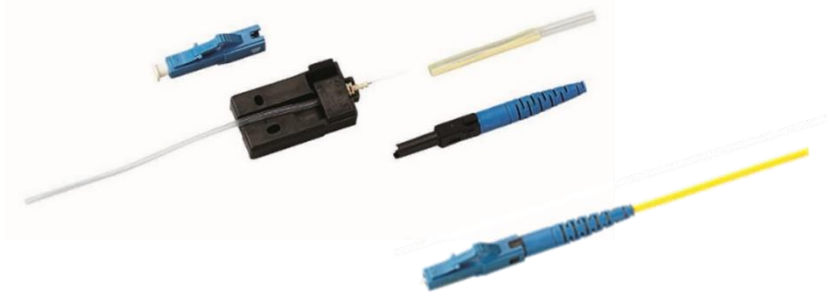

FuseConnect™ is designed to work with an industry standard cleaver and splicers utilising a fibre holder system and the simplified field installation process minimises the potential for operator error and expensive connector scrap, even in difficult field environments or in exposed conditions at remote site locations.

Our latest fusion splicers are also pre-programmed for FuseConnect™ terminations, which further simplifies the assembly process.

Features

- No epoxy, no polishing
- Easily fusion splicer termination operation
- FuseConnect is designed for 900 µm coated fiber, 2 mm / 3 mm cord and rectangle shaped drop/indoor cable

Specifications

1) 0.9 mm Fiber

Applicable Fiber	0.9 mm fiber (850–950 µm)		
Connector	SC, LC, ST, FC		
Fiber	SM	MM (OM1, OM2, OM3)	
Polishing	UPC	APC	PC
Housing Color	Blue	Green	OM1: Beige, OM2: Black, OM3: Aqua
Insertion Loss	≤ 0.4 dB		
Return Loss	≥ 50 dB	≥ 60 dB	-

2) 2 mm / 3 mm Code

Applicable Fiber/Cable	Ø 2 mm (Inside 0.9 mm fiber), Ø 3 mm (Inside 0.9 mm fiber) or both use		
Connector	SC, LC, ST, FC		
Fiber	SM	MM (OM1, OM2, OM3)	
Polishing	UPC	APC	PC
Housing Color	Blue	Green	OM1: Beige, OM2: Black, OM3: Aqua
Insertion Loss	≤ 0.4 dB		
Return Loss	≥ 50 dB	≥ 60 dB	-

3) Rectangular Shaped Cable

Applicable Fiber/Cable	Outdoor (3.1 x 2 mm) or Indoor (2 x 1.6 mm)	
Connector	SC	
Fiber	SM	
Polishing	UPC	APC
Housing Color	Blue	Green
Insertion Loss	≤ 0.4 dB	
Return Loss	≥ 50 dB	≥ 60 dB



Contact us

Ordering Information / Product Image (After assembly)

1) 0.9 mm Fiber

Fiber	Polishing	SC	LC	ST	FC
SM	UPC	SC-SF-SM-09	LC-SF-SM-09 (*A)	ST-SF-SM-09	FC-SF-SM-09
	APC	SC-SF-APC-09	LC-SF-APC-09 (*B)	-	FC-SF-APC-09
MM (OM1)	PC	SC-SF-GI6-09	LC-SF-GI6-09	ST-SF-GI6-09	FC-SF-GI6-09
MM (OM2)	PC	SC-SF-GI5-09	LC-SF-GI5-09	ST-SF-GI5-09	FC-SF-GI5-09
MM (OM3)	PC	SC-SF-10G-09	LC-SF-10G-09 (*C)	ST-SF-10G-09	FC-SF-10G-09

*A : LC-SF-SM-09



*B : LC-SF-APC-09



*C: LC-SF-10G-09



2-1) 2 mm Code Only

Fiber	Polishing	SC	LC	ST	FC
SM	UPC	SC-QA-SM-20 (*D)	LC-QA-SM-20 (*F)	ST-SF-SM-20	-
	APC	SC-QA-APC-20 (*E)	LC-QA-APC-20 (*G)	-	-
MM (OM1)	PC	SC-QA-GI6-20	LC-QA-GI6-20	ST-SF-GI6-20	-
MM (OM2)	PC	SC-QA-GI5-20	LC-QA-GI5-20	ST-SF-GI5-20	-
MM (OM3)	PC	SC-QA-10G-20	LC-QA-10G-20	ST-SF-10G-20	-

2-2) 3 mm Code Only

Fiber	Polishing	SC	LC	ST	FC
SM	UPC	SC-QA-SM-30	LC-SF-SM-30	ST-SF-SM-30	-
	APC	SC-QA-APC-30	LC-SF-APC-30	-	-
MM (OM1)	PC	SC-QA-GI6-30	LC-SF-GI6-30	ST-SF-GI6-30	-
MM (OM2)	PC	SC-QA-GI5-30	LC-SF-GI5-30	ST-SF-GI5-30	-
MM (OM3)	PC	SC-QA-10G-30	LC-SF-10G-30	-	-

2-3) Both Use for 2 mm and 3 mm Code

Fiber	Polishing	SC	LC	ST	FC
SM	UPC	SC-SF-SM-20/30 (*H)	-	-	FC-SF-SM-20/30
	APC	SC-SF-APC-20/30 (*J)	-	-	FC-SF-APC-20/30
MM (OM1)	PC	SC-SF-GI6-20/30	-	-	FC-SF-GI6-20/30
MM (OM2)	PC	SC-SF-GI5-20/30	-	-	FC-SF-GI5-20/30
MM (OM3)	PC	SC-SF-10G-20/30	-	-	FC-SF-10G-20/30

•QA type : xx-QA-xxx-xx

•SF type : xx-SF-xxx-xx

*D : SC-QA-SM-20

*E : SC-QA-APC-20

*F : LC-QA-SM-20

*G : LC-QA-APC-20

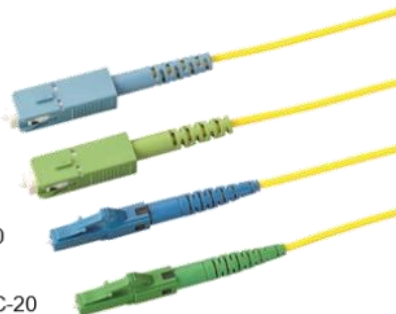

*H : SC-SF-SM-20/30

*J : SC-SF-APC-20/30



Contact us

3-1) Rectangular Shaped Cable: Outdoor (3.1 x 2 mm)

Fiber	Polishing	SC	LC	ST	FC
SM	UPC	SC-DC (*K)	-	-	-
	APC	SC-DC-APC	-	-	-

3-2) Rectangular Shaped Cable: Indoor (2 x 1.6 mm)

Fiber	Polishing	SC	LC	ST	FC
SM	UPC	SC-LFC (*L)	-	-	-

*K : SC-DC



*L : SC-LFC



Contact us

FuseConnect™ MPO

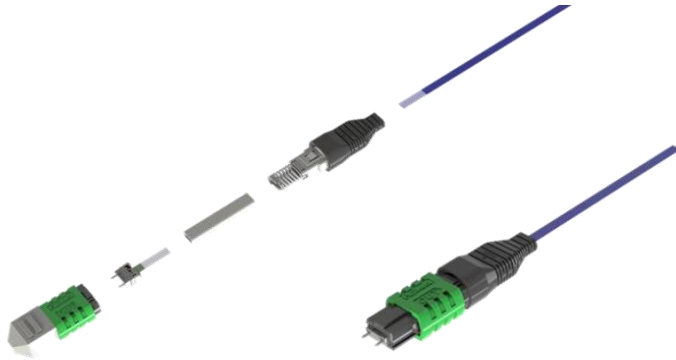

FuseConnect™ MPO splice-on, field-installable connectors are uniquely designed and feature just six components. The innovative factory pre-polished ferrule allows for a field-termination process that eliminates the need for polishing, adhesives and crimping in the field and minimizes the potential for operator error and expensive connector scrap. FuseConnect™ MPO is part of the FuseConnect™ splice-on connector family which includes SC, LC and ST style connectors.

The connector is designed for use with the new RT-02 ribbonizing tool which does not require ribbonizing glue resulting in a cleaner termination process.

FuseConnect™ MPO performs as an equivalent to the standard factory terminated MPO/MTP® assemblies. Designed to utilize standard ribbon, SpiderWeb Ribbon™, or loose tube cable, this connector helps minimize the complexity involved in the termination of a multi-fiber connection, allowing for a reliable and repeatable termination in field applications. Fujikura offers a tool kit as well as a variety of accessories designed to meet all your installation needs for your FuseConnect™ MPO application.

Specifications

Applicable Fiber / Cord	<ul style="list-style-type: none"> ● 12 fiber ribbon type (0.25 mm fiber) ● 3 mm cord type 			
Connector	MPO (12f)			
Type	SM (*1)	Low Loss SM	MM (OM1) (*2)	MM (OM4) (*3)
Polishing	APC		PC	
Housing Color	Green	Yellow	Beige	Aqua
Insertion Loss (*4)	≤ 0.75 dB	≤ 0.35 dB	≤ 0.35 dB	
Return Loss (*4)	≥ 65 dB	≥ 65 dB	-	
Remark	6 pcs packing unit			

*1. Mode field diameter: 8.6 μm (For 9.2 μm type, please consult us.)

*2. GI 62.5/125, IEC 60793-2-10 A1b

*3. GI 50/125, IEC 60793-2-10 A1a.3

*4. with reference connector, SM @ 1310, 1550 nm, MM @ 850, 1310 nm



Contact us

Ordering Information

Type	Polishing	Male (Connector with Guide Pin)	Female (Connector without Guide Pin)
SM	APC	FUSECONNECT-MPO-S-MALE-SM15-6	FUSECONNECT-MPO-S-FEMALE-SM15-6
Low Loss SM	APC	FUSECONNECT-MPO-S-MALE-LLSM15-6	FUSECONNECT-MPO-S-FEMALE-LLSM15-6
MM (OM1)	PC	FUSECONNECT-MPO-S-MALE-GI6-6	FUSECONNECT-MPO-S-FEMALE-GI6-6
MM (OM4)	PC	FUSECONNECT-MPO-S-MALE-OM4-6	FUSECONNECT-MPO-S-FEMALE-OM4-6

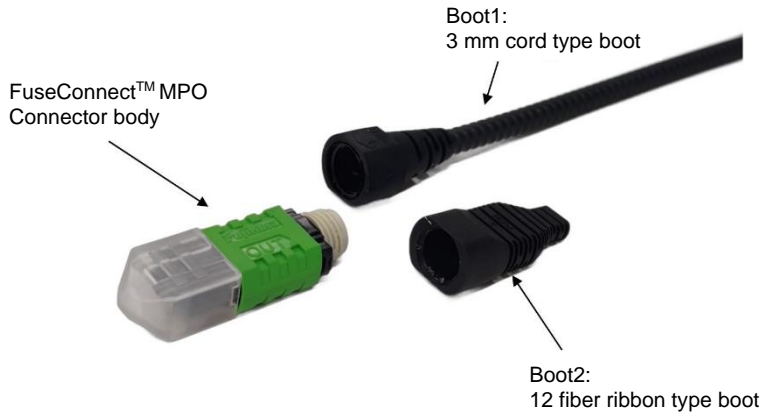

Optical product:
RT-02/Ribbonizing tool



Contact us

Mechanical Splice

FMSEZ-025



Assembly tools for FMSEZ-025



FMSEZ-025/09



The Mechanical Splice Element enables efficient field splicing without the need for a fusion splicer.

Features

- Two types of connections are possible: \varnothing 0.25 mm / \varnothing 0.25 mm fiber and \varnothing 0.25 / \varnothing 0.9 mm (For \varnothing 0.9 mm fiber, use thermoplastic resin coating)

Specifications

		Mechanical Splice	
		\varnothing 0.25 mm fiber	\varnothing 0.25 mm fiber and \varnothing 0.9 mm fiber
		FMSEZ-025	FMSEZ-025/09
Size		40 x 4 x 4 (mm)	
Insertion Loss		Average 0.1 dB, Maximum 0.4 dB	
Reflection Loss		\geq 40 dB	
Required tools		Fujikura's Cleaver and etc (Assembly tools is attached in product)	Assembly tools(see next page), Fiber stripper, Fujikura's Cleaver and etc
Connector Apply	\varnothing 0.25 mm – \varnothing 0.25 mm	Available	Available
	\varnothing 0.25 mm – \varnothing 0.9 mm	-	Available
	\varnothing 0.9 mm – \varnothing 0.9 mm	-	Available
Applicable Temperature Range		\varnothing 0.25 mm fiber: -40–75 °C \varnothing 0.9 mm fiber: 0–50 °C	

Assembly Tools for FMSEZ-025/09

	Model Number	Remark
(1)	FMSECO-TL2-EZ	Assembly tools for FMSEZ-025/09
(2)	FMSECO-FH09	Fiber holder for 0.9mm fiber
(3)	FMSECO-FH05/025	Fiber holder for 0.25mm fiber
(4)	FMSECO-SP-C2	Spacer for using Fujikura's cleaver

(1)



(2)



(3)



(4)



Contact us

Push-Type Cleaners



Easy-to-use solution for cleaning fiber optic connectors on jumpers and in adapters. Since over 85% of network outages are attributed to dirty and/or damaged connectors, it is critical to clean every connector! The patented One-Click Cleaner uses the mechanical push action to advance an optical grade cleaning tape while the cleaning tip is rotated to ensure the fiber end-face is effectively, but gently, cleaned. It is a favorite of field technicians for its ease of use, durability, effectiveness, and small size.

Features

- Patented single-action cleaning in a small ergonomic design
- Variety of sizes and types for different connector styles
- Cleans connectors in both jumpers and bulkhead adapters
- Low cost per clean

Applications

- Removing oil, dust, and dirt without damaging delicate fiber end-faces
- Both dry and wet cleaning (add cleaning fluid)
- Clean connectors in tight spaces
- Field or laboratory use

Order Information

Description	Model Number
One-Click Cleaner SC PRO (775+ cleans)	SCPRO-CLK-A
One-Click Cleaner LC PRO (775+ cleans)	LCPRO-CLK-A
One-Click Cleaner SC, ST, FC (500+ cleans)	SC-CLK-B
One-Click Cleaner Mini-500 SC, ST, FC (500+ cleans)	SC-MINI-CLK-A
One-Click Cleaner MU/LC (500+ cleans)	MU/LC-CLK-C
One-Click Cleaner Mini-500 MU/LC (500+ cleans)	MU/LC-MINI-CLK-A
One-Click Ultra Cleaner 2.5 (enlarged cleaning) SC, ST, FC (500+ cleans)	M250-E-CLK-A
One-Click Cleaner HOC, Hardened Optic Connectors (500+ cleans)	HOC-CLK-A
One-Click Cleaner D-LC, Duplex LC (2 x 500+ cleans)	DLC-CLK-A
One-Click Cleaner SN Duplex (2 x 500+ cleans)	SN-CLK-A
One-Click Cleaner CS/MDC Duplex (2 x 500+ cleans)	CS/MDC-CLK-A
One-Click Cleaner ODC, outdoor connector (500+ cleans)	ODC-CLK-A
One-Click Cleaner M20, 2.0 mm ferrule (500+ cleans)	M20-CLK-A
One-Click Cleaner MT-RJ (500+ cleans)	MTRJ-CLK-A
One-Click Cleaner MPO (500+ cleans)	MPO-CLK-D
One-Click Cleaner MPO-16 (500+ cleans)	MPO16-CLK-A
One-Click Cleaner MT-BP (500+ cleans)	MT-BP-CLK-A



Contact us

One-Click™ Cleaner PRO Series

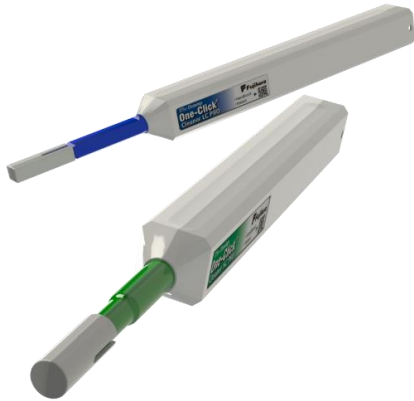

Features

- PRO series maintaining the features of One-Click Cleaner:
 - Patented single-action cleaning in a small ergonomic design
 - Variety of sizes and types for different connector styles
 - Cleans connectors in both jumpers and bulkhead adapters
 - Low cost per clean
- Reduced cleaning time by eliminating the guide cap
- Increased number of cleanings by 1.5 times compared to Fujikura conventional products
- High cleaning performance by moving the cleaning string and rotating the head at the same time
- Compact/Extendable cleaning nozzle

Applications

- Removing oil, dust, and dirt without damaging delicate fiber end-faces
- Clean connectors in tight spaces
- Field or laboratory use

One-Click Cleaner is an easy-to-use solution for cleaning fiber optic connectors on jumpers and in adapters. Since over 85% of network outages are attributed to dirty and/or damaged connectors, it is critical to clean every connector!

The patented One-Click Cleaner uses the mechanical push action to advance an optical grade cleaning tape while the cleaning tip is rotated to ensure the fiber end-face is effectively, but gently, cleaned. It is a favorite of field technicians for its ease of use, durability, effectiveness, and small size.

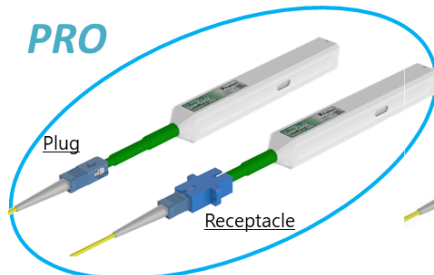

PRO
Not required to attach guide cap

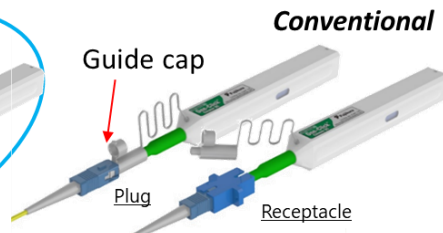

Conventional
Required to attach guide cap

Reduced Cleaning Time by Eliminating the Guide Cap

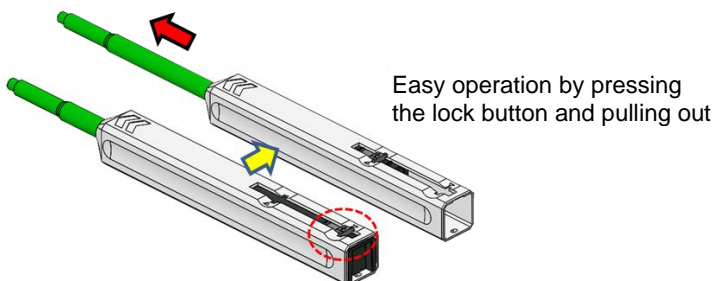

Easy operation by pressing the lock button and pulling out

Compact/Extendable Cleaning Nozzle (Note)



With one click





High Cleaning Performance (Note)

Note: Features are the same as the conventional One-Click Cleaner SC/LC.



Contact us

Specifications

	One-Click™ Cleaner SC PRO	One-Click™ Cleaner LC PRO
Model Number	SCPRO-CLK-A	LCPRO-CLK-A
Color	Green	Blue
Applicable Connector	SC connector	LC connector
Dimensions (mm)	W 17.5 x H 17.5 x L 185 (with nozzle extended: L 220)	
Cleaning Times	775 times or more	
Cleaning Method	Dry cleaning	
Appearance		



Contact us

One-Click™ Cleaner MPO ESD



Features

- The cleaner body is made from highly conductive resin, allowing for rapid dissipation of static electricity.
- It effectively suppresses static electricity generated on the ferrule end-face during cleaning, reducing the risk of dust attraction.
- Suitable for use in ESD(electrostatic discharge) protected area and compliant with IEC 61340-5-1(*1) standards.

The One-Click™ Cleaner MPO ESD is inaugural multi-connector(MPO) cleaning solution compliant with IEC IEC 61340-5-1(*1) standards. This cutting-edge device effectively mitigates static electricity on the connector's end face during the cleaning process, thereby preventing the movement of dust caused by static charges. It is particularly well-suited for optical transceivers sensitive to static electricity and for connections that demand exceptional low-loss performance.

Specifications

	One-Click™ Cleaner MPO ESD
Type Name	MPOESD-CLK-A
Applicable connector	MPO (12/24c MPO, SM/MM)
Dimension(mm) (Not included guide cap)	W19 x H43.5 x L194
Cleaning times	≤ 500 times
Surface resistance (Ω) (*1)	< 1 x 10 ¹²
Charge decay(sec) (*1)	< 2

*1) IEC 61340-5-1: ESD management standard, ESD(Electro Static Discharge)



Contact us